



PROSIMPLUS APPLICATION EXAMPLE

CYCLOHEXANE PLANT

EXAMPLE PURPOSE

In this example, a cyclohexane production unit is represented. It is a typical chemical industrial process that includes a reaction section where the product is synthesized followed by a separation section where products and by-products are separated.

Particular points detailed in this example are:

- The use of a constraint management module in order to reach a specification.
- The use of an information stream to split a heat exchanger between a temperature set point and a simple exchanger, in order to avoid a stream recycle.

ACCESS	<input checked="" type="checkbox"/> Free-Internet	<input type="checkbox"/> Restricted to ProSim clients	<input type="checkbox"/> Restricted	<input type="checkbox"/> Confidential
--------	---------------------------------------------------	-------------------------------------------------------	-------------------------------------	---------------------------------------

CORRESPONDING PROSIMPLUS FILE	PSPS_E02_EN - CyclohexanePlant.pmp3
-------------------------------	-----------------------------------------------------

Reader is reminded that this use case is only an example and should not be used for other purposes. Although this example is based on actual case it may not be considered as typical nor are the data used always the most accurate available. ProSim shall have no responsibility or liability for damages arising out of or related to the use of the results of calculations based on this example.

TABLE OF CONTENTS

1. PROCESS MODELING	3
1.1. Process description	3
1.2. Process flowsheet	3
1.3. Specifications	4
1.4. Components	4
1.5. Thermodynamic model	4
1.6. Operating conditions	4
1.7. "Hints and Tips"	6
1.7.1. <i>Constraint Management</i> module	6
1.7.2. Heat exchanger splitting	7
2. RESULTS	7
2.1. Comments on results	7
2.2. Mass and energy balances	8
2.3. Column C101 liquid profiles	9
3. REFERENCES	10

1. PROCESS MODELING

1.1. Process description

This example is taken from a publication [1] which briefly describes the process. The objective of the process is to produce cyclohexane through catalytic hydrogenation of benzene in vapor phase. The reactive mixture is fed in vapor phase in the reactor, where it gets in contact with a Nickel based catalyst. The following reaction takes place:

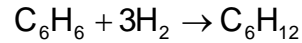

The conversion rate of the reactor (R101) is 99,9% molar, with respect to Benzene. The reactor is a plug-flow reactor and operating conditions are such that cyclohexane isomerisation in methyl-cyclopentane does not occur. The vapor from the reactor outlet pre-heat the reactor feed. Then, they are cooled before entering a liquid-vapor separation vessel (S101). The separated hydrogen is then recycled to the feed of the reactor (streams C12-C13). To avoid methane accumulation (inert component in the hydrogen feed stream) a purge is carried out. The liquid phase of the separation vessel is then fed to a distillation column (C101 from streams C14 - C15 - C16) in order to separate light components (stream C17) from cyclohexane, obtained at the bottom liquid product (stream C18 – C19 – C20) with the required specifications.

1.2. Process flowsheet

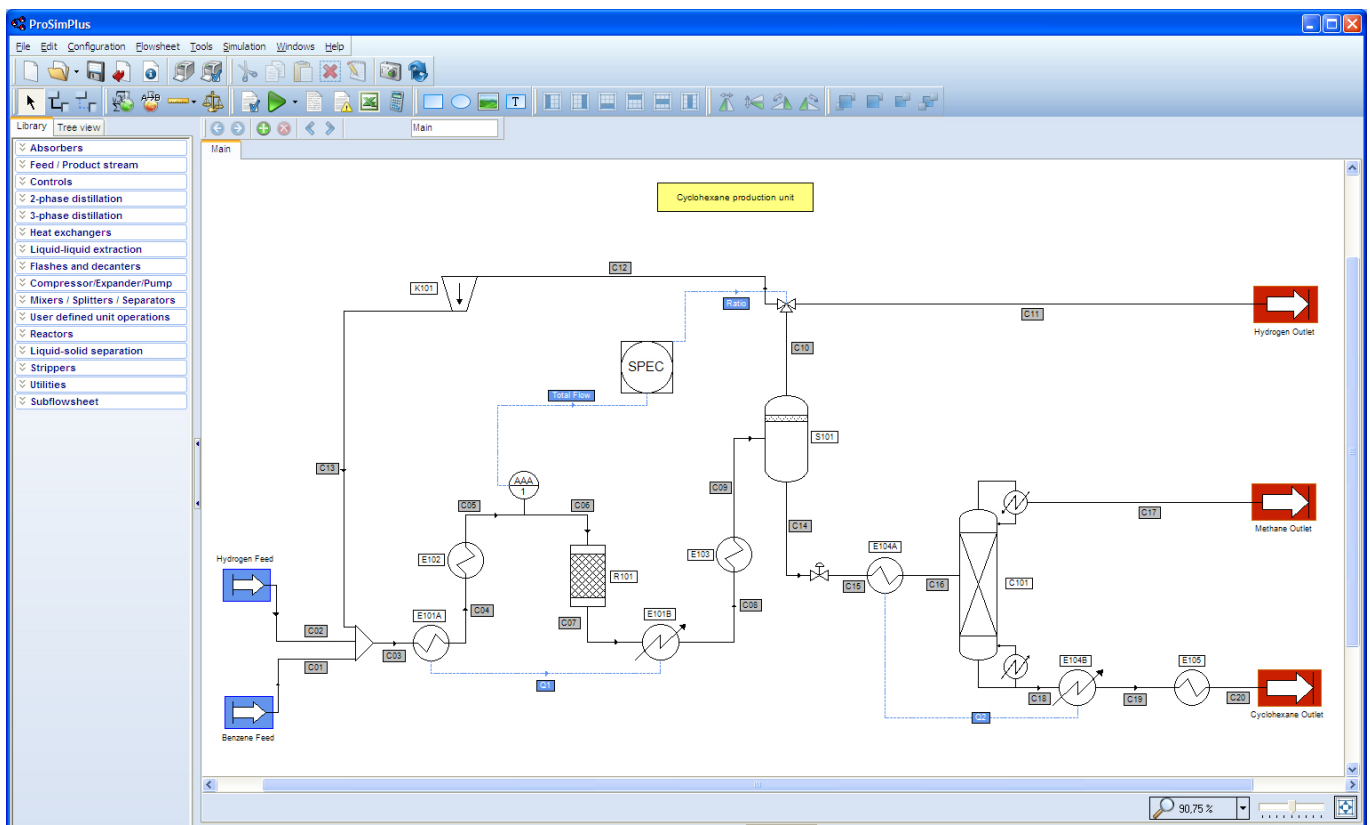

Process flowsheet

1.3. Specifications

The main specifications imposed on the process are:

- ✓ Total molar flowrate fed to reactor R101 equal to 5000 kmol/hr
- ✓ And at the level of the distillation column:
 - Cyclohexane purity: $\geq 99.9\%$ wt
 - Cyclohexane recovery ratio at the bottom liquid product of the column: 99.99%

Energy consumption is also reduced as much as possible, recovering heat duties between cold and hot streams.

1.4. Components

Components taken into account in the simulation are taken from the ProSim standard database, provided with ProSim's software. These components are:

- ❖ Hydrogen
- ❖ Methane
- ❖ Benzene
- ❖ Cyclohexane

1.5. Thermodynamic model

Given the nature of the components in the process, the thermodynamic model used to represent phases equilibria and the enthalpy calculations is the Soave-Redlich-Kwong (SRK) [2] cubic equation of state, without binary interaction parameters.

1.6. Operating conditions

- ✓ Process feed

	<i>Benzene feed stream C01</i>	<i>Hydrogen feed stream C02</i>
Hydrogen (kmol/hr)	-	1383.83
Methane (kmol/hr)	-	39.13
Benzene (kmol/hr)	370.44	-
Temperature (K)	311	311
Pressure (atm)	37.735	37.735

- ✓ Compressor K101

<i>Operating parameters</i>	<i>Value</i>
Isentropic efficiency	0.75
Exhaust pressure (atm)	34

✓ Reactor R101

<i>Operating parameters</i>	<i>Value</i>
Type of reactor	simple
Benzene conversion rate (%)	99.9
Pressure drop (atm)	1.02
Output temperature (K)	497

✓ Column C101

<i>Operating parameters</i>	<i>Value</i>
Column type	Two-phase distillation column
Reflux molar flowrate	1
Distillate vapor flowrate (kmol/hr)	10.6
Overhead pressure (atm)	15.6
Pressure drop (atm)	0.4

Additional column specification:

<i>Specification</i>	<i>Product type</i>	<i>Components</i>	<i>Value</i>	<i>Phase</i>	<i>Type</i>	<i>Action</i>
1 : Recovery ratio	Bottom liquid product	Cyclohexane	0.9999	Liq.	Mol.	Vapor distillate flowrate

✓ Liquid Vapor Separator (Flash) S101

<i>Operating parameters</i>	<i>Value</i>
Separator type	Liquid-Vapor separator
Operating mode	Adiabatic
Operating pressure (atm)	28.9

✓ Valve V101

<i>Operating parameters</i>	<i>Value</i>
Valve type	Expansion valve
Output pressure (atm)	19.7

✓ Valve V102

<i>Operating parameters</i>	<i>Value</i>	<i>Note</i>
Valve type	Three way valve	
Splitting rate for the stream C12 (%)	95	This rate will be adjusted in order to reach a total molar flowrate equal to 5000 kmol/hr at the reactor RX1 input.

✓ Heat Exchangers

<i>Name</i>	<i>Type</i>	<i>Output Temperature (K)</i>	<i>Pressure drop (atm)</i>
E101A	Cooler/heater	410	0.34
E101B	Simple heat exchanger	-	0.68
E102	Cooler/heater	422	0.34
E103	Cooler/heater	322	0.34
E104A	Cooler/heater	408	1.36
E104B	Simple heat exchanger	-	1.36
E105	Cooler/heater	322	0.68

1.7. "Hints and Tips"

1.7.1. Constraint Management module

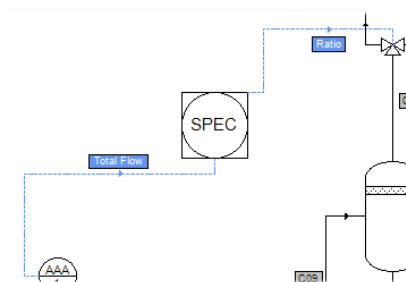

The objective of this module is to set the total flowrate of the C06 stream, by adjusting the purge valve ratio (V102). User specifies the required value in the MEASUREMENT module (MS01), which he sets on C06 stream. This module measures the actual value of the total flowrate and sends to the constraint management module (SPEC module) the difference between the required value (set point) and the measured value through an information stream (blue dotted line, "Total Flow").

The constraint management module will then adjust the splitting ratio in order to satisfy the constraint. It will simultaneously ensure the convergence of the recycling loop.

1.7.2. Heat exchanger splitting

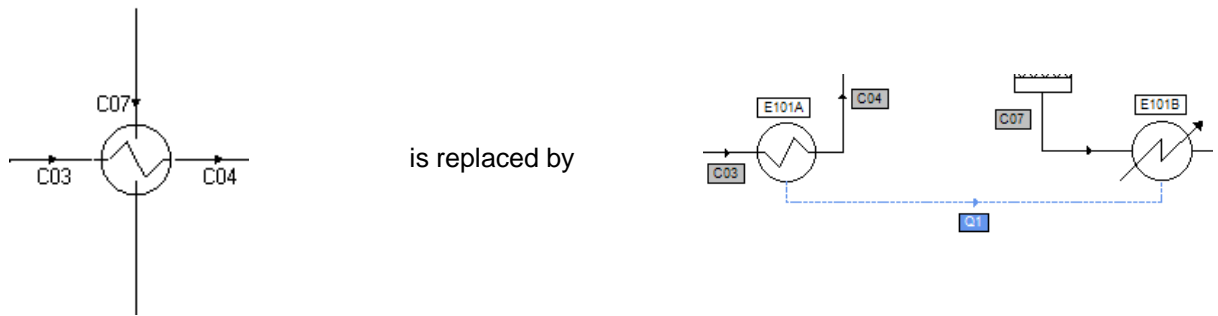

This way to model a two-stream heat exchanger enables to avoid a stream recycle that would penalize the calculation by splitting the heat exchanger in two parts. This way of modeling is frequently used in process simulation. The C03 stream temperature is set by a cooler/heater (E101A) that calculates the heat duty required to satisfy this constraint.

This duty is sent by the information stream Q1 to the simple heat exchanger module (E101B), on stream C07. As stream C07 temperature and heat duty are known, the module can calculate the output temperature of the exchanger.

The same approach is used to model the energy recovery by pre-heating the feed stream of the distillation column with its bottom liquid product.

2. RESULTS

2.1. Comments on results

The calculation sequence (order of calculation of the unit operations) is automatically generated. At the recycling loop level there is no initialized stream, and ProSimPlus selected to converge on stream C13.

The cycle convergence is reached after 3 iterations.

In order to fulfill the constraint on the reactor R101 (total input flowrate = 5000 kmol/hr), the final splitting ratio at the level of valve V102 is 91,3%.

The distillation column converges after 15 trials, without any initialization in temperature nor in composition in the column.

Two operating parameters are simultaneously adjusted in order to reach the purity and recovery ratio specifications: the reflux flowrate and the vapor distillate flowrate. At the end of simulation the vapor distillate flowrate and the reflux flowrate are 10 kmol/hr (reflux ratio of 1).

The reboiler duty obtained is $1.6 \cdot 10^6$ kcal/hr.

2.2. Mass and energy balances

This document presents only the most relevant stream results. In ProSimPlus, mass and energy balances are provided for every stream. Results are also available at each unit operation level (result tab in the configuration window).

Streams		C01	C02	C06	C07	C13
From		Benzene Feed	Hydrogen feed	MS01	R101	K101
To		M101	M101	R101	E101B	M101
Partial flows		kg/h	kg/h	kg/h	kg/h	kg/h
HYDROGEN		0.0	2789.6	8415.3	6177.0	5625.6
METHANE		0.0	627.7	6554.4	6554.4	5926.6
BENZENE		28935.8	0.0	28939.1	28.9	3.3
CYCLOHEXANE		0.0	0.0	3910.6	35059.1	3910.6
Total flow	kg/h	28935.8	3417.4	47819.3	47819.3	15466.2
Mass fractions						
HYDROGEN		0.000000	0.816309	0.175980	0.129173	0.363737
METHANE		0.000000	0.183691	0.137065	0.137065	0.383199
BENZENE		1.000000	0.000000	0.605175	0.000605	0.000214
CYCLOHEXANE		0.000000	0.000000	0.081779	0.733157	0.252850
Physical state		Liquid	Vapor	Vapor	Vapor	Vapor
Temperature	K	311.00	311.00	422.00	497.00	340.65
Pressure	atm	37.735	37.735	32.980	31.960	34.000
Enthalpic flow	kcal/h	-2792474.0	132169.9	5269459.6	7878904.2	997841.4
Vapor molar fraction		0.00000	1.00000	1.00000	1.00000	1.00000

Streams		C16	C11	C17	C20
From		E104A	V102	C101	E105
To		C101	Process outlet 3	Process outlet 2	Process outlet 1
Partial flows		kg/h	kg/h	kg/h	kg/h
HYDROGEN		12.5	538.8	12.5	1.71E-07
METHANE		60.1	567.7	60.1	5.96E-05
BENZENE		25.3	0.3	0.0	25.3
CYCLOHEXANE		30773.9	374.6	3.1	30770.8
Total flow	kg/h	30871.8	1481.4	75.7	30796.1
Mass fractions					
HYDROGEN		0.000405	0.363737	0.165245	0.000000
METHANE		0.001947	0.383198	0.794042	0.000000
BENZENE		0.000820	0.000214	0.000054	0.000822
CYCLOHEXANE		0.996828	0.252850	0.040658	0.999178
Physical state		Liq./Vap.	Vapor	Vapor	Liquid
Temperature	K	408.00	321.58	276.53	322.00
Pressure	atm	18.340	28.900	15.600	13.930
Enthalpic flow	kcal/h	-1162293.3	51564.4	-1788.0	-2527478.7
Vapor molar fraction		0.00811	1.00000	1.00000	0.00000

2.3. Column C101 liquid profiles

Columns profiles can be accessed from their configuration window (Profiles tab). Double click on the selected profile to generate the graph.

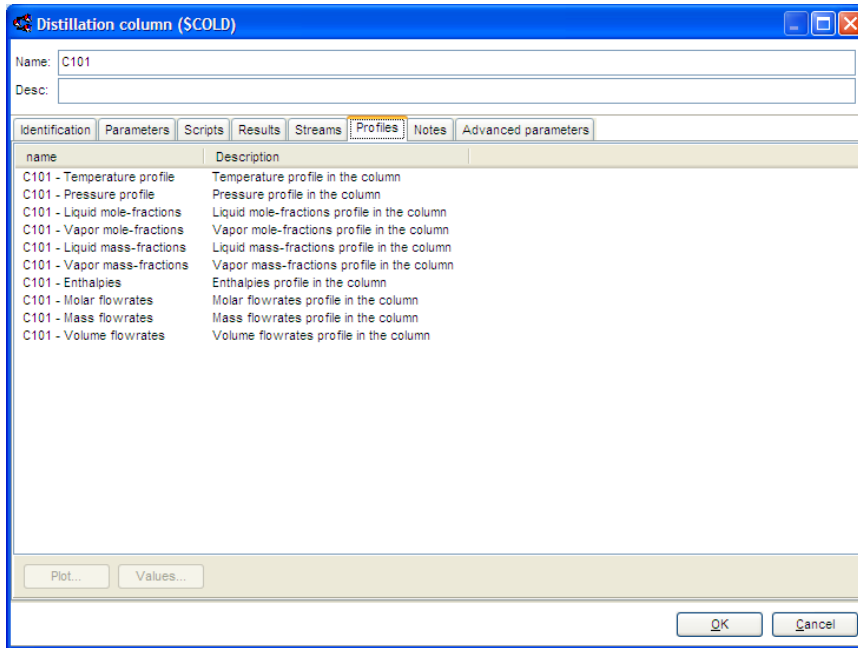

C101 - Temperature profile

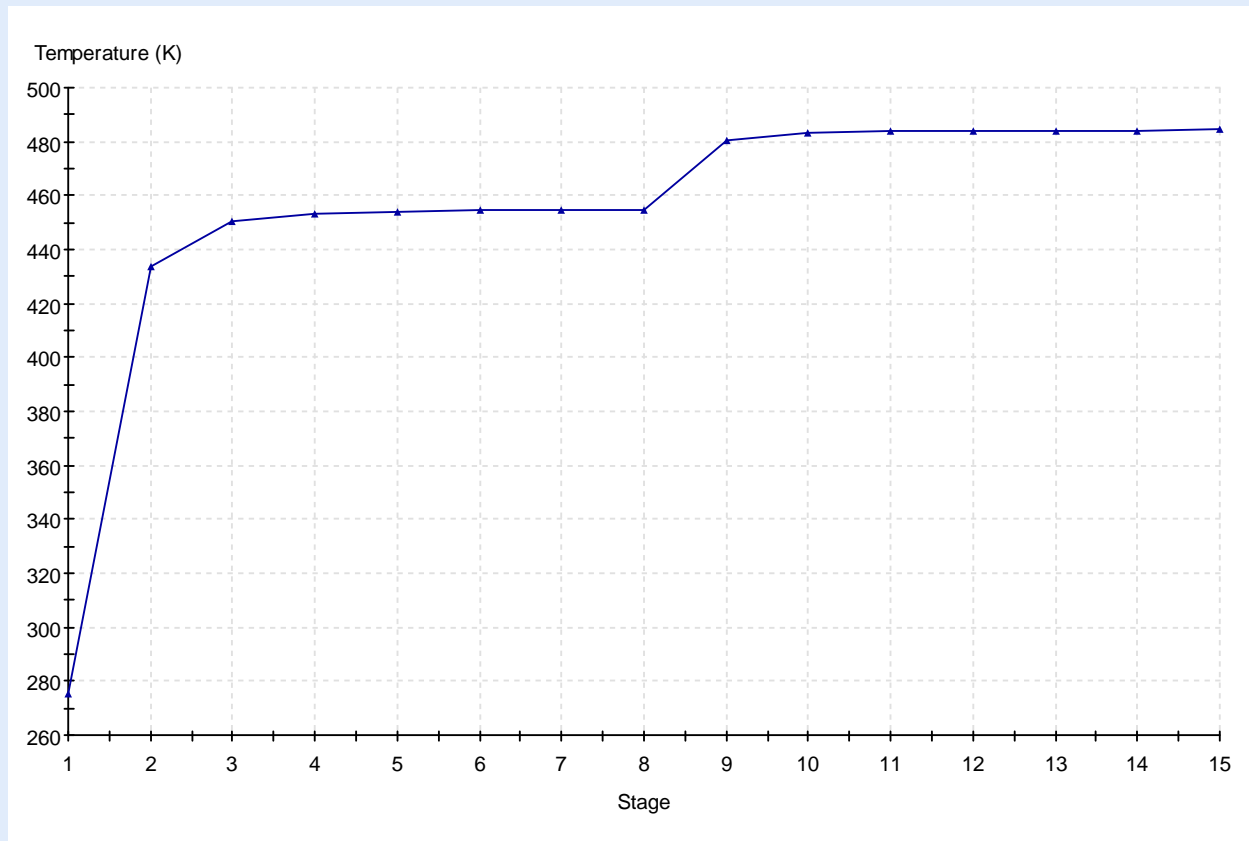

Temperature profile in the column

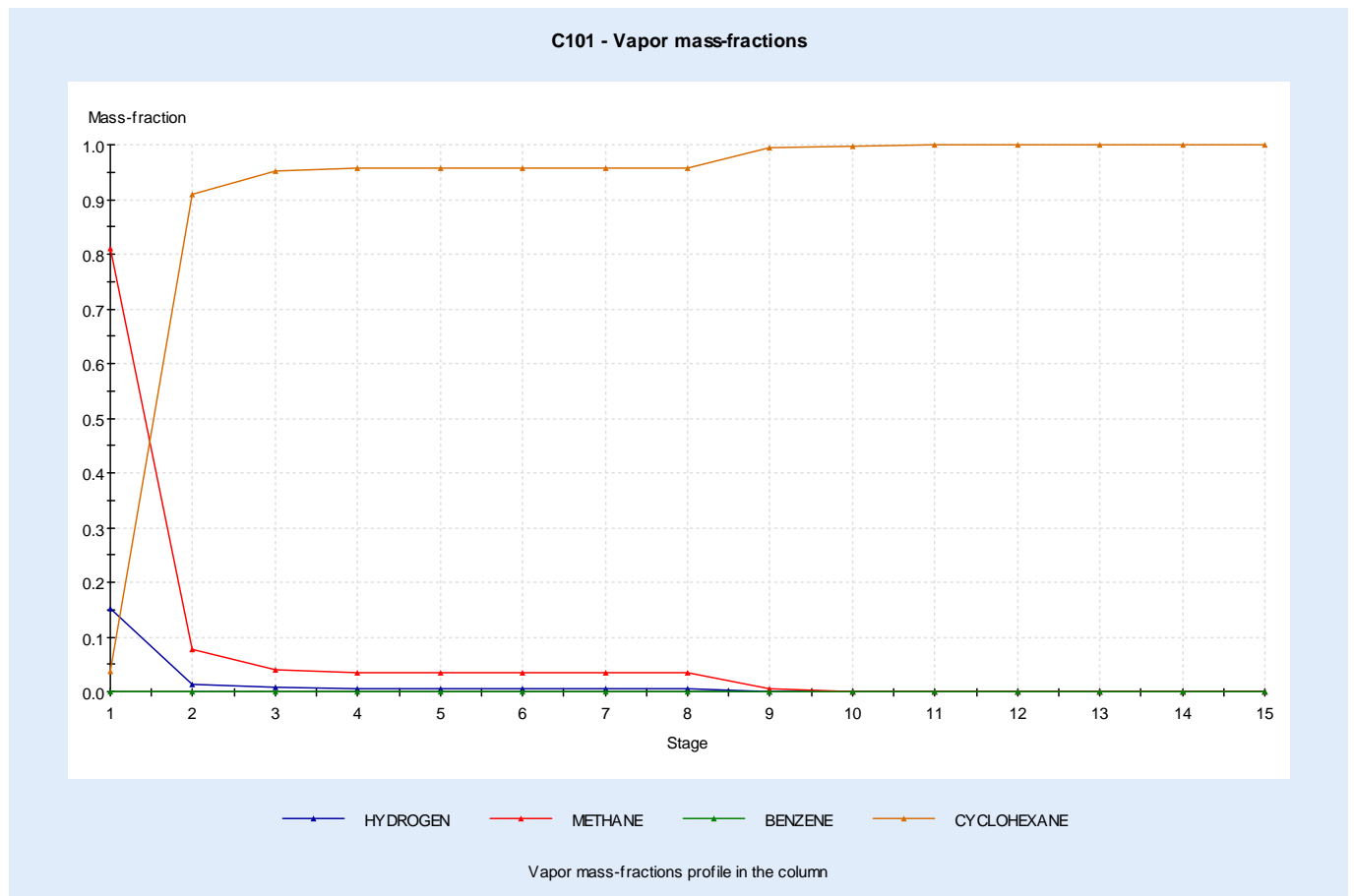

3. REFERENCES

- [1] Cyclohexane
ARCO Technology Inc.
Hydrocarbon Processing, November 1977, p 143
- [2] Soave G.
"Equilibrium constants from a modified Redlich-Kwong equation of state"
C.E.S., 27, 6,1197-1203 (1972)