



BATCHREACTOR APPLICATION EXAMPLE

SINGLE-PHASE REACTOR WITH HEATING/COOLING DEVICE

RISK ANALYSIS

EXAMPLE PURPOSE

This example shows the modelling of a monophasic reactor for which the heating device is described. Another interest is to set two stop events for a same step. This example also allows to simulate a failure case on the reactor.

ACCESS	<input checked="" type="checkbox"/> Free-Internet	<input type="checkbox"/> Restricted to ProSim clients	<input type="checkbox"/> Restricted	<input type="checkbox"/> Confidential
--------	---	---	-------------------------------------	---------------------------------------

BATCHREACTOR CORRESPONDING FILES

BATCHREA_E07_EN - Single-phase reactor.pbpr
BATCHREA_E07_EN - Single-phase reactor - failure.pbpr

Reader is reminded that this use case is only an example and should not be used for other purposes. Although this example is based on actual case it may not be considered as typical nor are the data used always the most accurate available. ProSim shall have no responsibility or liability for damages arising out of or related to the use of the results of calculations based on this example.

TABLE OF CONTENTS

1. INTRODUCTION	3
2. REACTION MECHANISM	3
3. COMPONENTS	3
4. THERMODYNAMIC MODEL	4
5. REACTION MATHEMATICAL MODEL	4
6. REACTION MODEL IMPLEMENTATION USING SIMULIS REACTIONS	5
7. SIMULATION	6
7.1. Process description	6
7.1.1. Reactor	6
7.1.2. Heating/cooling device	8
7.1.3. Mixing device	9
7.1.4. Feed	9
7.1.5. Operating mode	10
7.2. Results	11
7.3. Simulation of a failure	13
8. REFERENCES	15
9. NOMENCLATURE	16

1. INTRODUCTION

This example deals with the synthesis of monoalkylester from maleic anhydride and 1-hexanol. Only the liquid phase is taken into consideration. Some technical elements are taken into account, such as:

- ✓ Heating/cooling device of the vessel,
- ✓ Mixing device.

The operating mode only includes one operating step, during which the reaction occurs. An example allowing to study a failure scenario is also studied.

2. REACTION MECHANISM

The reaction mechanism is as follows:

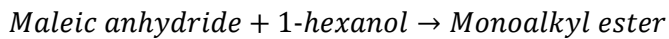

Namely:



3. COMPONENTS

The components taken into account in the simulation appear in the table below:

Name	Formula	CAS Number
Maleic anhydride (*)	C ₄ H ₂ O ₃	108-31-6
1-hexanol(*)	C ₆ H ₁₄ O	111-27-3
Monoalkylester	C ₁₀ H ₁₆ O ₄	55000-01-6

Components with an asterisk are taken from the standard database of Simulis Thermodynamics, thermodynamics server used in BatchReactor. The thermophysical properties stored in this database are the DIPPR recommended values [ROW17].

Monoalkylester has been created using the **Clone this compound** functionality in Simulis Thermodynamics. The cloned component is the sebacic acid (CAS number: 111-20-6). The properties that have been modified are the following ones:

- ✓ CAS number : Arbitrary number (55000-01-6)
- ✓ Chemical formula : C₁₀H₁₆O₄
- ✓ Molecular weight : 200,24752 g.mol⁻¹
- ✓ Enthalpy of vaporization (mass) : Same as sebacic acid (**)
- ✓ Vapor specific heat (mass) : Same as sebacic acid (**)
- ✓ Liquid specific heat (molar)

$$Cp_L = 163500 + 652,299988 \times T$$

- ✓ Liquid density : Same as sebacic acid (**)
- ✓ Liquid dynamic viscosity:

$$\ln(\mu_L) = -13,2580004 + \frac{3206,8999}{T} - 0,0298519991 \times \ln(T)$$

For the properties with (**), the molar properties defined for the components have been modified in order for the mass properties to be the same as the properties of the sebacic acid (molecular weights ratio).

4. THERMODYNAMIC MODEL

The reactor is modelled as being a single-phase reactor (§ 7); this way, no vapor-liquid equilibrium is taken into account. The **Ideal** thermodynamic profile has been selected in Simulis Thermodynamics.

5. REACTION MATHEMATICAL MODEL

The reaction rate of the synthesis of monoalkylester from maleic anhydride and 1-hexanol is modelled by an Arrhenius law:

$$r = k_0 \times \exp\left(-\frac{Ea}{RT}\right) \times C_{Maleic\ anhydride} \times C_{1-hexanol}$$

With:

$$k_0 = 4,92.10^{15} l. mol^{-1}. h^{-1}$$

$$Ea = 105 kJ. mol^{-1}$$

6. REACTION MODEL IMPLEMENTATION USING SIMULIS REACTIONS

The reaction presented in the paragraphs 2 and 5 was described in Simulis Reactions, as shown in the next screen shot.

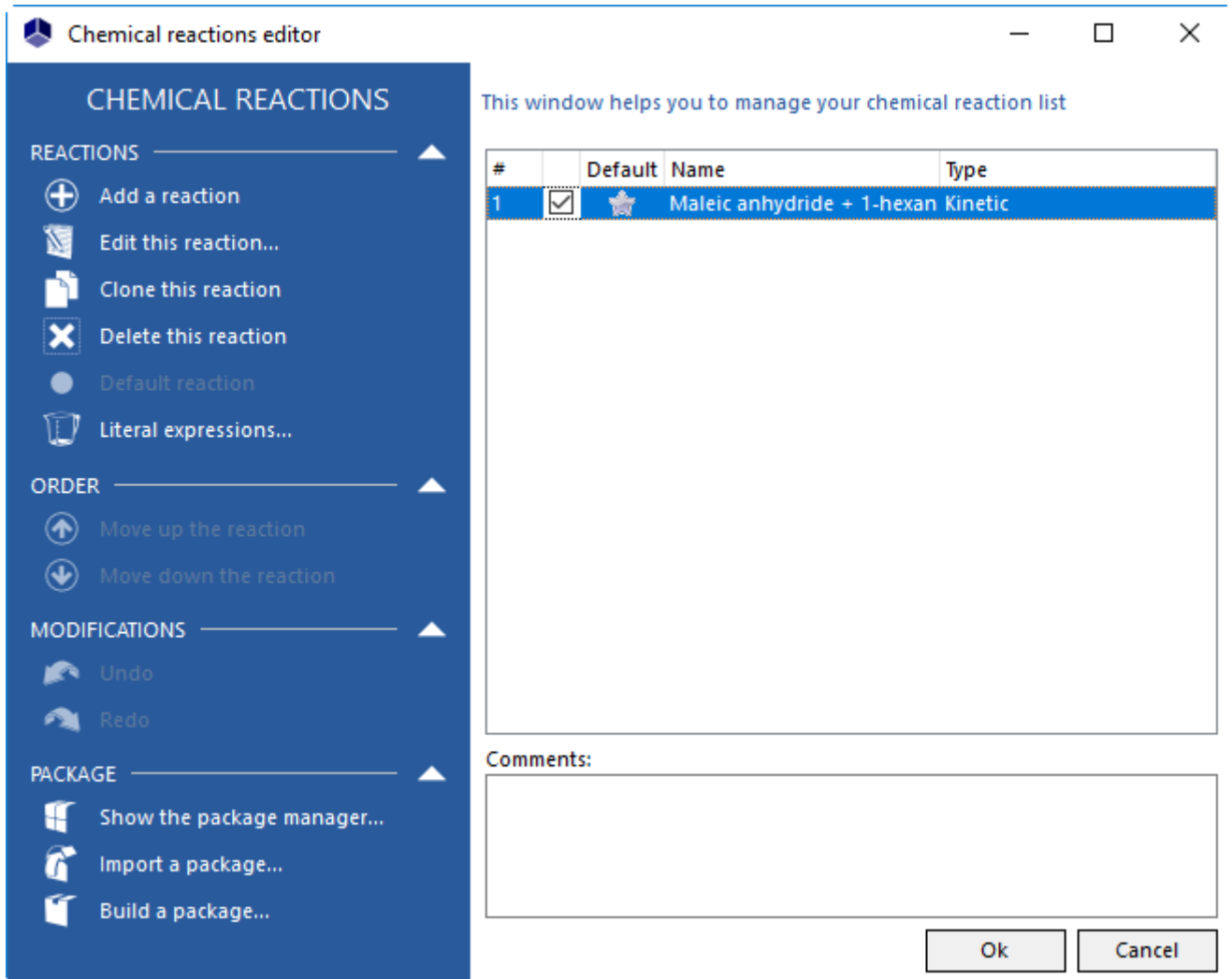

This reaction follows the “classic” Arrhenius law. Thus it is described with the standard Simulis Reactions interface. The reaction occurs in liquid phase.

The reaction heat is -33 500 cal/mol (negative value as this reaction is exothermic).

7. SIMULATION

7.1. Process description

7.1.1. Reactor

A single-phase reactor is used for the synthesis reaction of monoalkylester.

The initial conditions appear in the table below:

Initial conditions	
Temperature	85°C
Pressure	1 atm
Initial load	
Maleic anhydride	500 kg

The bottom vessel geometry is described below:

Vessel bottom geometry
✕

Vessel bottom geometry is known

Image

Type of vessel bottom geometry

Torispherical

Parameters

Number of baffles	0
Vessel diameter (D)	1.2 m
Vessel bottom height (H)	0 m
Curve radius #1 (R1)	1.2 m
Curve radius #2 (R2)	12 cm

Restore

Technology

OK

Cancel

The reactor is made of stainless steel.

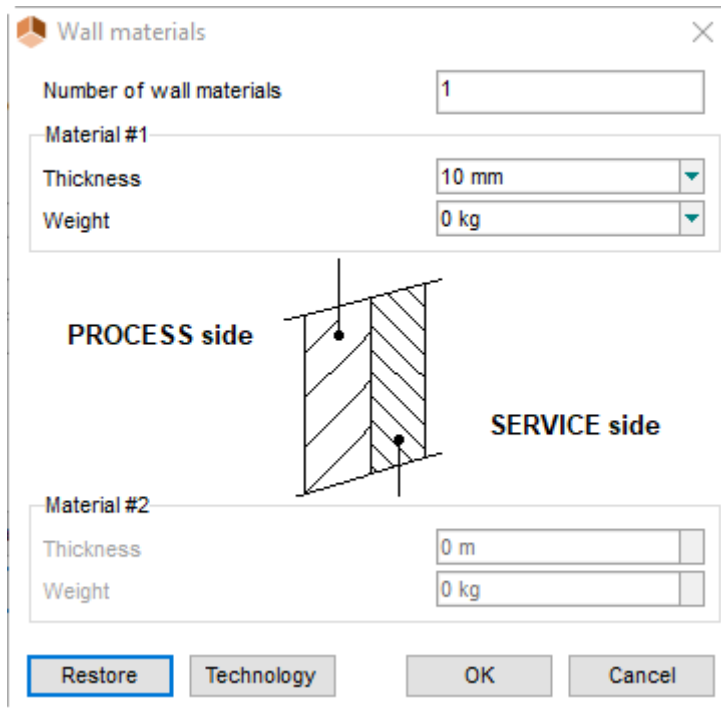

The thermal conductivity of stainless steel is considered to be equal to 19 W/m¹.K⁻¹. The thermal conductivity is specified for each operating step.

The alarms are as follows:

	Volume	Temperature
Minimum	1 l	20°C
Maximum	10 m ³	200°C

7.1.2. Heating/cooling device

The reactor is equipped with a wall heat exchanger (partial-pipe jacket), with the following characteristics:

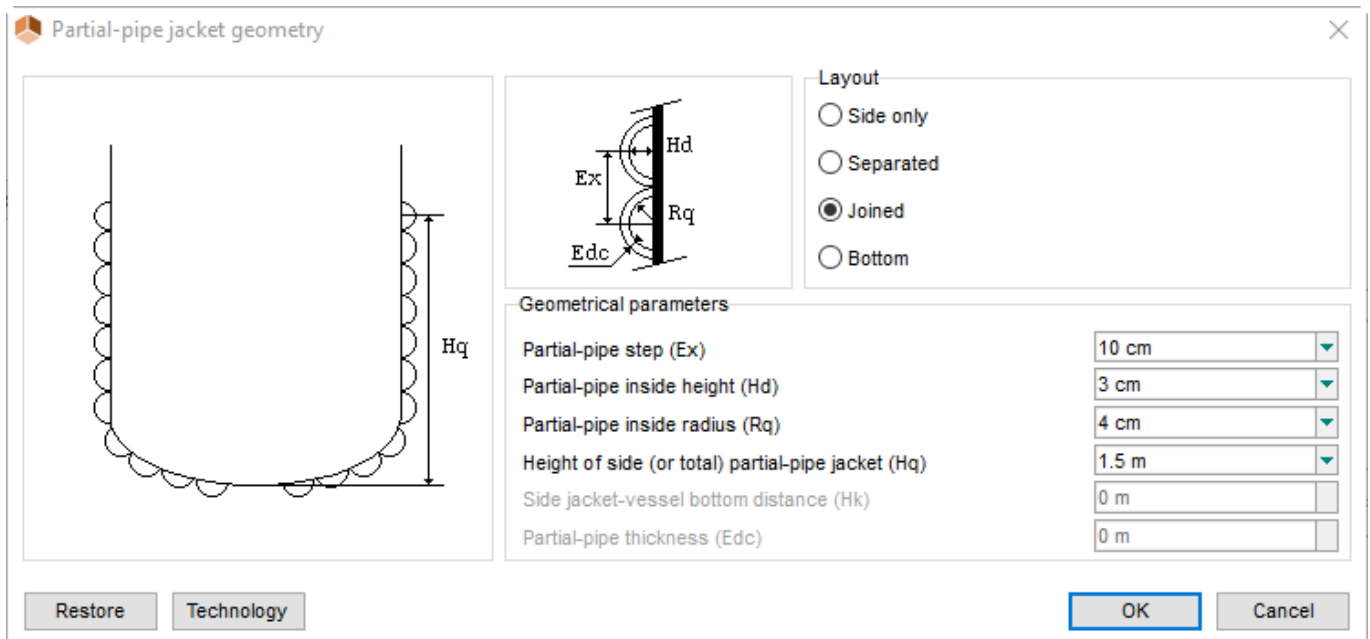

The characteristics of the thermal fluid appear in the following table. The inlet temperature of the utility fluid will be automatically adjusted in order to keep the reactor at the specified temperature.

Type	Other
Inlet temperature (initial value)	25°C
Mass flowrate	10 000 kg/h
Points number	1
Reference temperature	20°C
Specific heat	1 cal.g ⁻¹ .K ⁻¹
Density	1 000 kg.m ⁻³
Dynamic viscosity	1 cP
Thermal conductivity	0,6 W.m ⁻¹ .K ⁻¹

7.1.3. Mixing device

The mixing device characteristics appear in the following screenshot. The rotation speed is 60 rpm for each operating step.

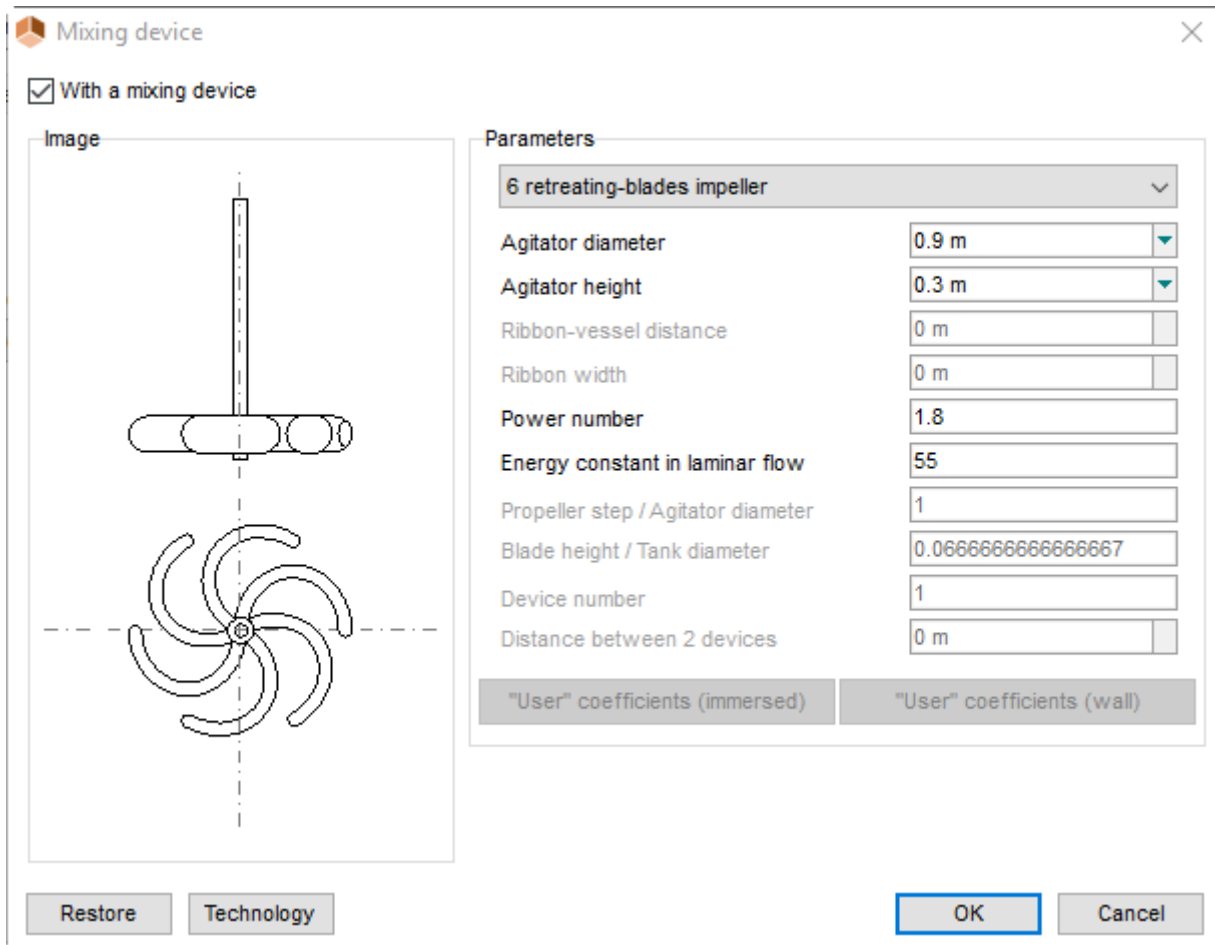

The agitator height applies to the distance between the agitator and the vessel bottom.

7.1.4. Feed

A continuous flow of 1-hexanol (reactant of the reaction with maleic anhydride) is fed all along the simulation:

Temperature	95°C
Pressure	1 atm
1-hexanol flowrate	200 kg/h

7.1.5. Operating mode

The operating mode includes only a single operating step during which one of the reactants is fed (1-hexanol) to react with the other reactant already present in the initial load (maleic anhydride). The reactor temperature is kept constant at 85°C by acting on the utility fluid inlet temperature.

Parameter	Step
Type	Specified TR with thermal device
Temperature	85°C
Reactor pressure	1 atm
Stop event	Time elapsed since the beginning of the step = 5 h or Partial load in maleic anhydride < 10 kg

The scenario is presented on the left part of this screenshot and the flowsheet on the right part.

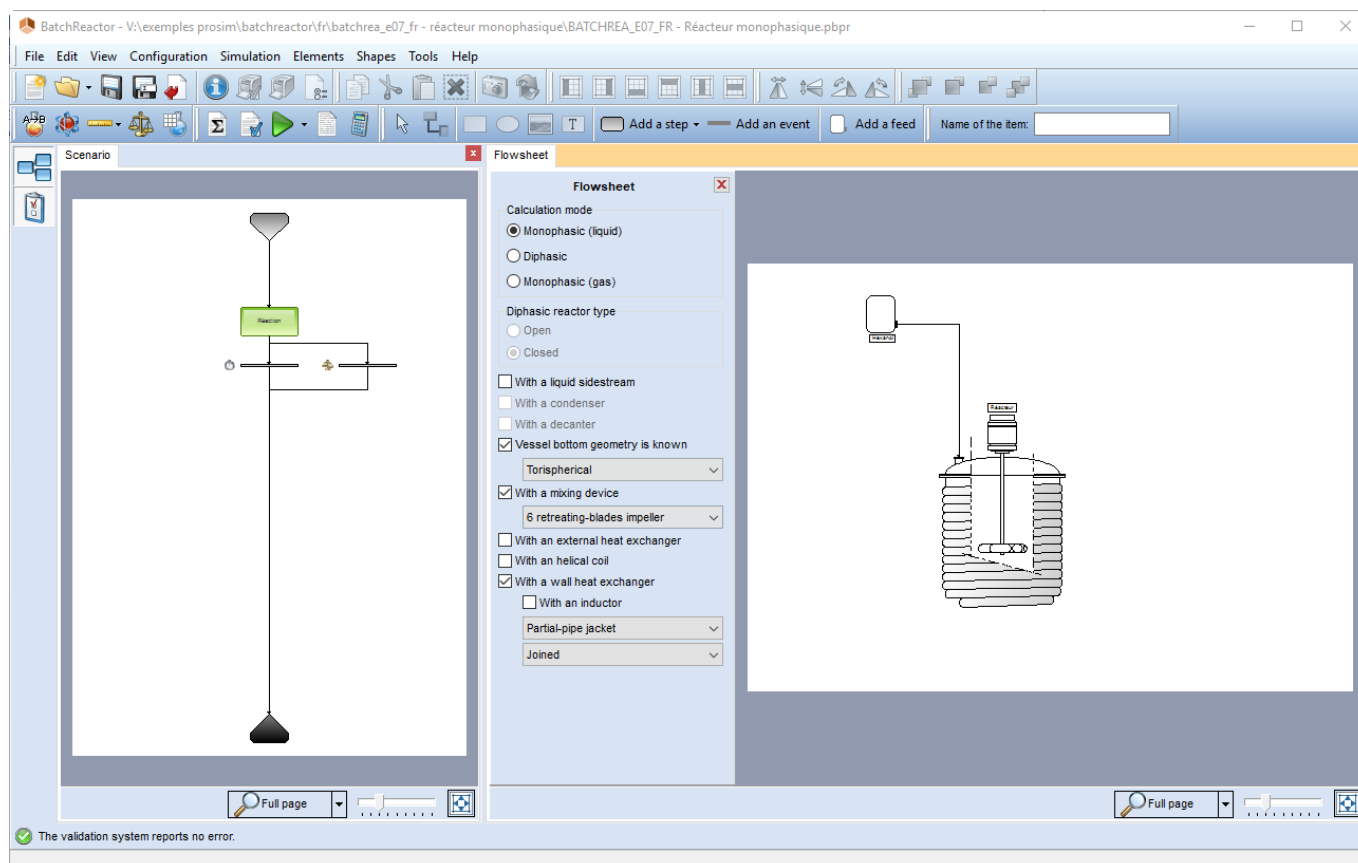

7.2. Results

The following graph shows the evolution of the mass fractions in the reactor. The maleic anhydride content only decreases. Indeed, this reactant is present in the initial load and is not fed. It is consumed all along the operation. The content in 1-hexanol continues to increase as the feed flowrate is higher than the consumption by the reaction. The content in monoalkylester increases until the depletion in maleic anhydride drastically slows down the reaction. The content in monoalkylester then decreases through the effect of the dilution by the feed in 1-hexanol that is no longer consumed (also because of the maleic anhydride depletion).

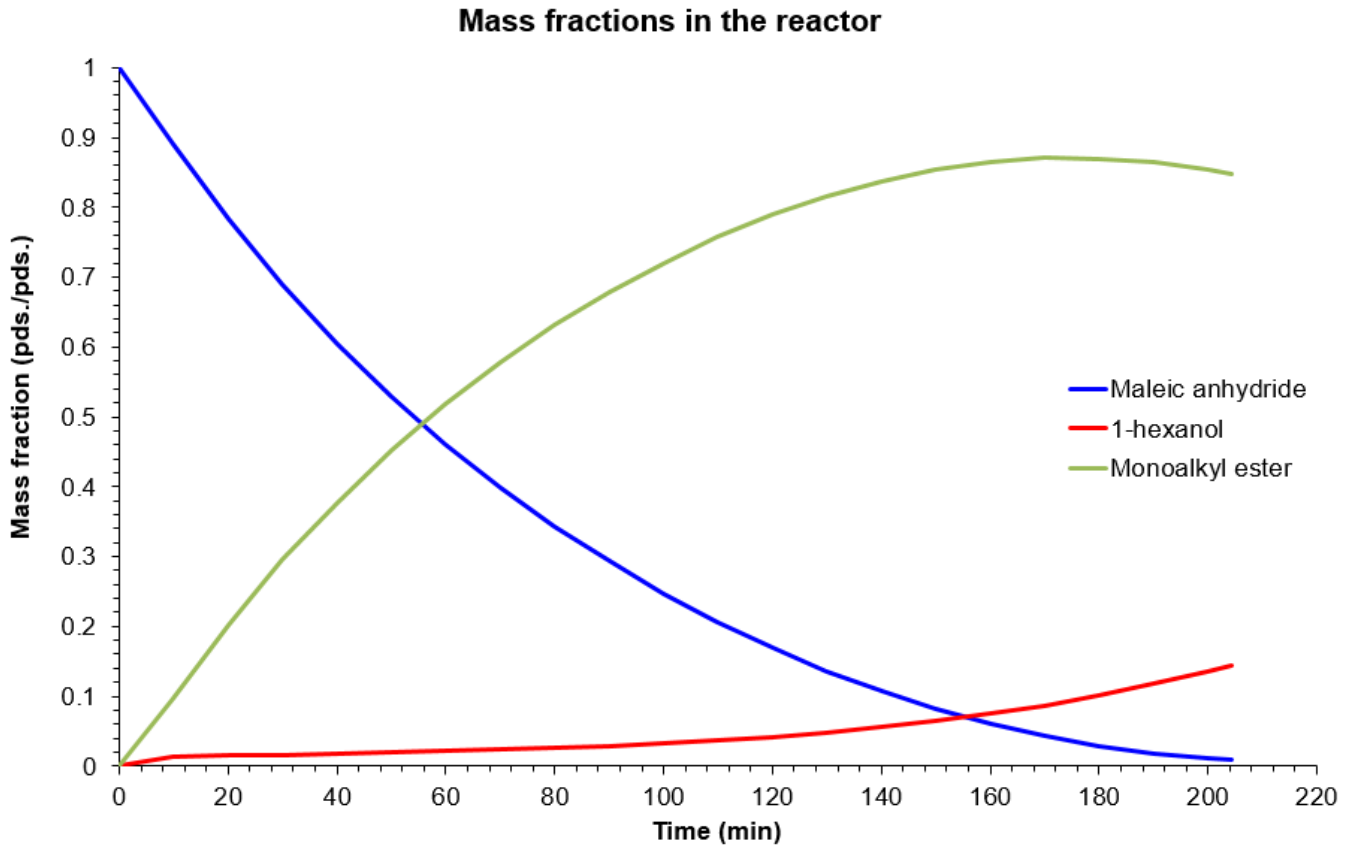

The following graph shows the different temperature profiles. The reactor temperature is effectively kept constant at 85°C. The inlet temperature of the utility increases over time. Indeed, all along the process, the reaction slows down and produces less heat. Therefore, at constant flowrate, the utility no longer needs to be that cool to carry away the heat released by the chemical reaction and to keep constant the reactor temperature.

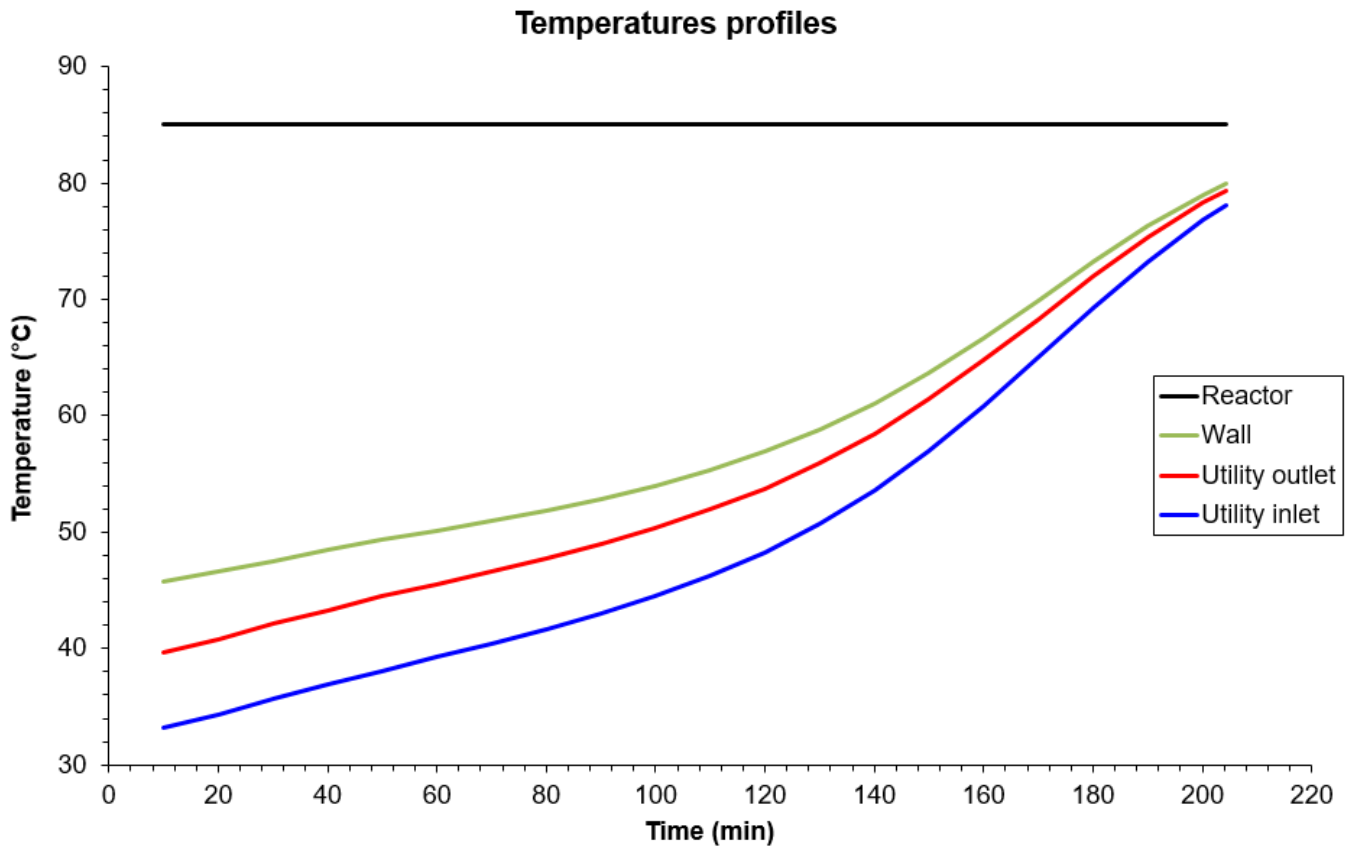

7.3. Simulation of a failure

The aim is to simulate the simultaneous stop of the mixing device and of the temperature control after an hour. The feed of 1-hexanol is kept open. The modifications of the operating mode appear in red in the following table.

Parameter	Reaction step	Failure step
Type	Specified TR with thermal device	Variable heat duty
Temperature	85°C	-
Reactor pressure	1 atm	
Stop event	Time elapsed since the beginning of the step = 5 h (*) or Partial load in maleic anhydride < 10 kg (*) or Time elapsed since the beginning of the step = 1 h	Time elapsed since the beginning of the step = 5 h

The events with an asterisk (*) belong to the nominal case, they have been kept.

The scenario is presented on the left part of this screen shot and the flowsheet on the right part.

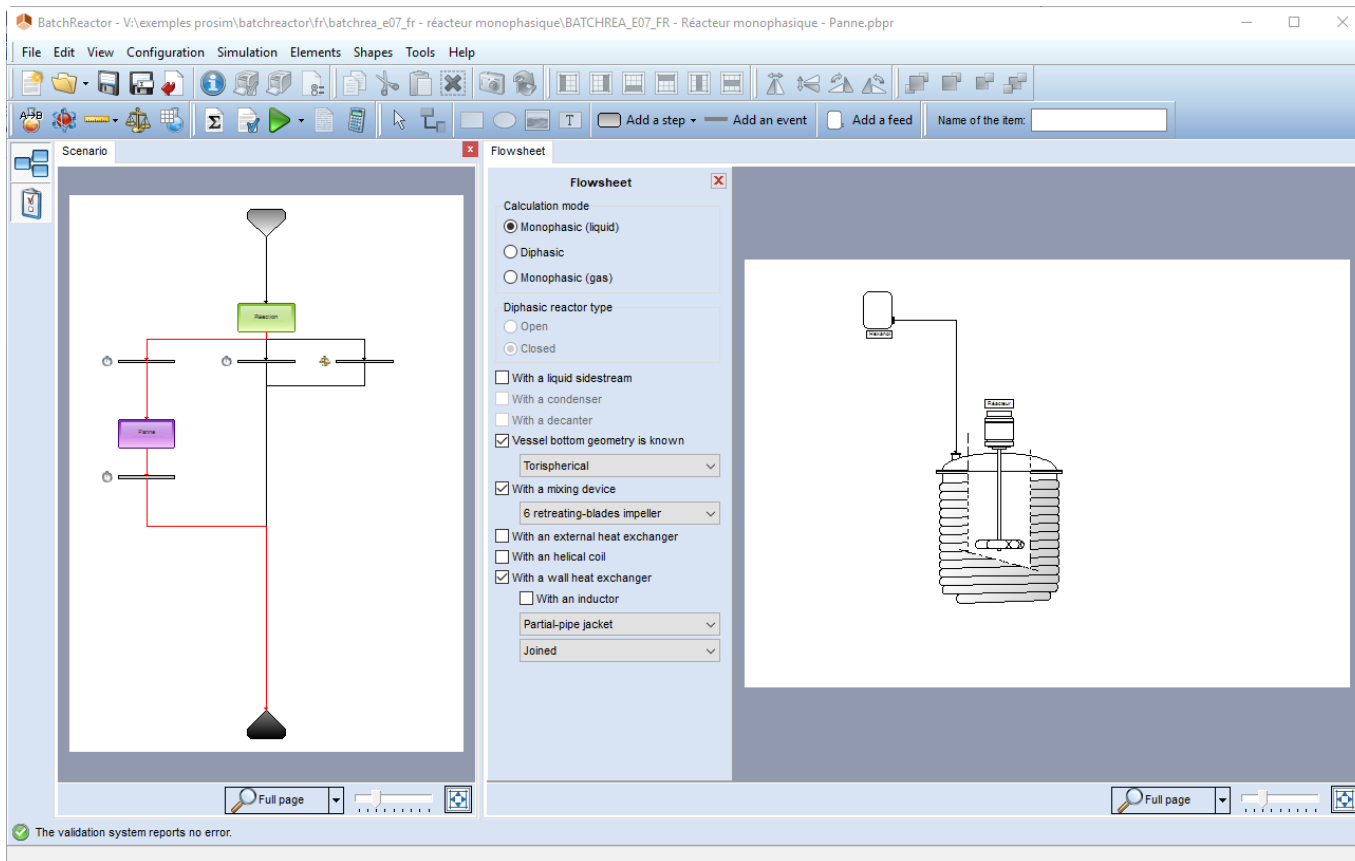

The following graph shows the evolution of the reactor temperature. When stopping the agitation after an hour, the heat transfer only occurs by natural convection, and is then less effective. Moreover, stopping the regulation no longer decreases accordingly the inlet temperature of the utility fluid. The temperature of the reactor then increases to reach the alarm value defined (200°C) in little more than an hour.

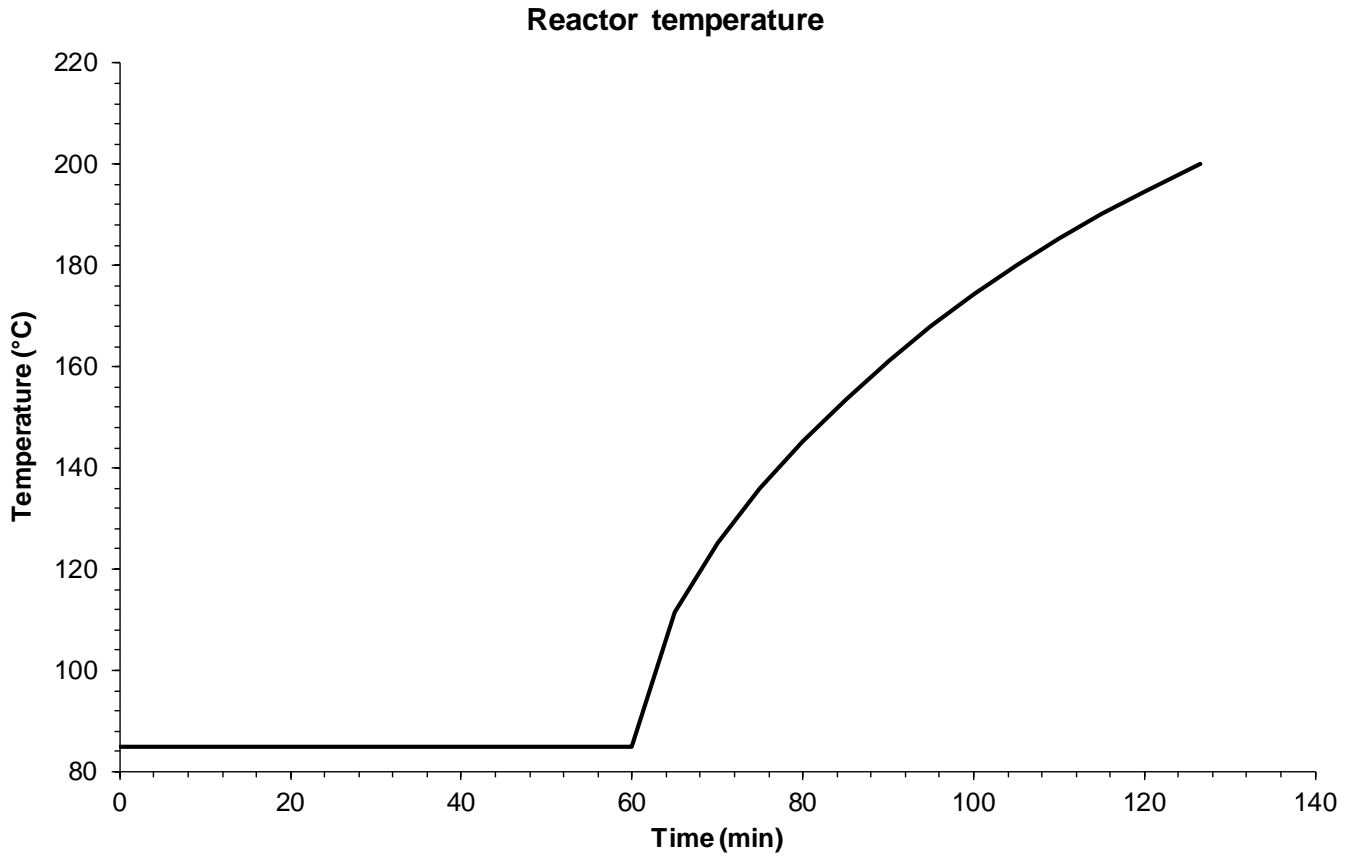

8. REFERENCES

- [ROW17] ROWLEY R.L., WILDING W.V., OSCARSON J.L., GILES N.F., “DIPPR® Data Compilation of Pure Chemical Properties”, Design Institute for Physical Properties, AIChE, New York, NY (2017)

9. NOMENCLATURE

C_i	Concentration of component i	mol.l ⁻¹
Cp_L	Liquid specific heat	J.kmol ⁻¹ .K ⁻¹
Ea	Activation energy of the reaction	J.mol ⁻¹
k_0	Pre-exponential factor of the reaction	l.mol ⁻¹ .h ⁻¹
r	Rate of the reaction	mol.l ⁻¹ .h ⁻¹
R	Constant of the perfect gas	J.mol ⁻¹ .K ⁻¹
T	Temperature	K
μ_L	Liquid dynamic viscosity	Pa.s